

WAVE PANEL

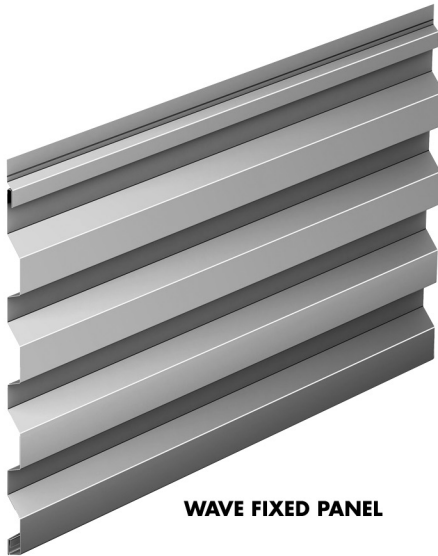

WAVE FIXED PANEL

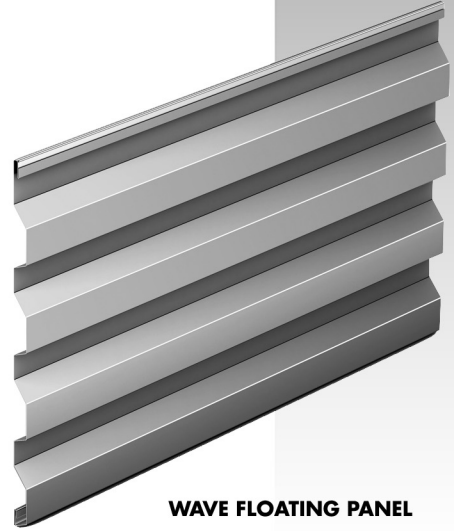

WAVE FLOATING PANEL

Panel/Trim/Accessories



WAVE

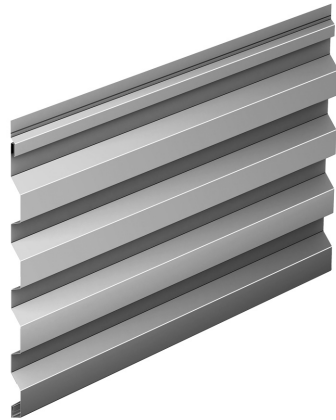

Wave Fixed

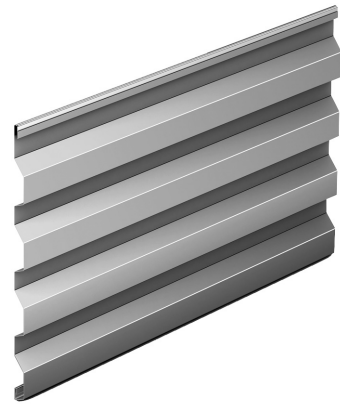

Wave Floating

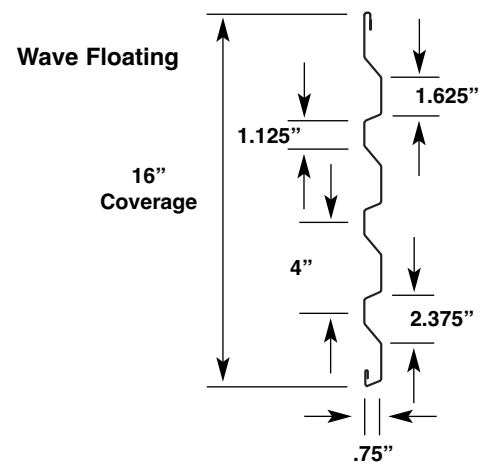
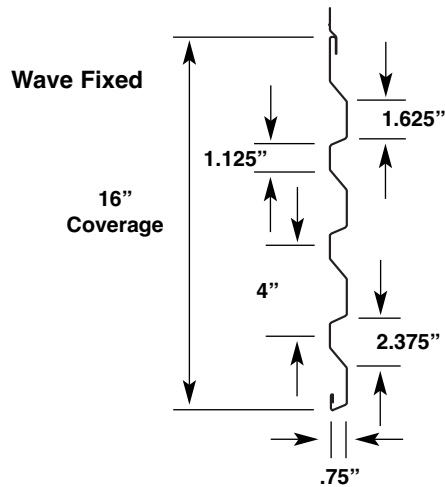

Wave Tables and Section Properties

For any available Testing Data, Section Properties, or Load Tables, please visit www.mcelroymetal.com. For additional information, please contact the **McElroy Engineering Department at 1-800-950-9082**.

Details:

- Concealed fastener wall panel
- Typically installed horizontally, but can be installed vertically
- Wave Fixed used for panel lengths 40' or less
- Wave Fixed has a concealed fastening flange
- Wave Floating is used for panels in lengths up to 50'
- Wave Floating utilizes a dip
- Wave Panel is produced in Houston, TX
- Oil canning is a natural occurrence in metal panels and is not cause for panel rejection

Panel Options:

- Panel width: 16"
- Coating:
 - Kynar 500® (PVDF)
- Substrate:
 - Standard 24 GA Galvalume®
 - Optional 22 GA Galvalume
- This panel cannot be lapped: MT171 or MT172 is required to connect panels

TRIM

24 GA.

**Outside Corner Trim
MT-55**

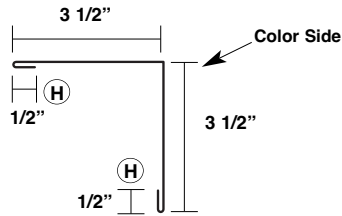

**Inside Corner Trim
MT-56**

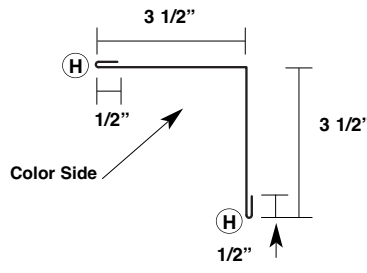

**Flat Trim Without Reveal - Notched
(Houston Plant Only)
MT-171**

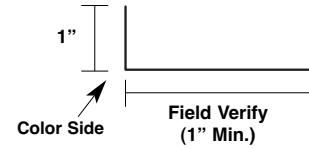

**Vertical Reveal - Notched
(Houston Plant Only)
MT-172**

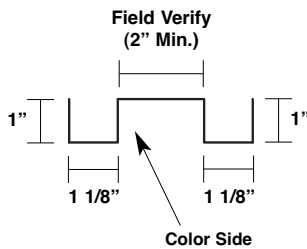

**Jamb Trim - Notched (Left)
(Houston Plant Only)
MT-173L**

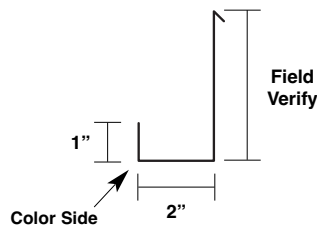

**Jamb Trim - Notched (Right)
(Houston Plant Only)
MT-173R**

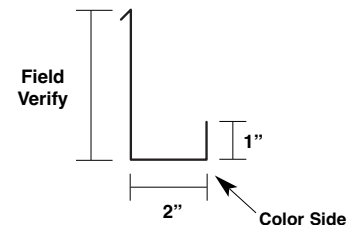

**Outside Corner Cleat - Notched (Left)
(Houston Plant Only)
MT-174**

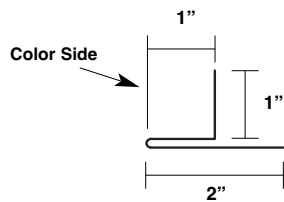

**Outside Corner Cleat - Notched (Right)
(Houston Plant Only)
MT-175**

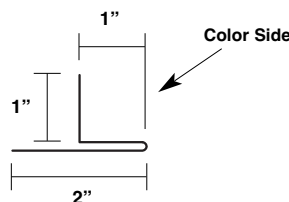

**Zee Closure
MT-184**

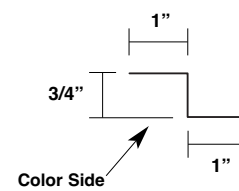

**Inside Corner Trim - Notched
MT-WAV-CRN-IS-STD**

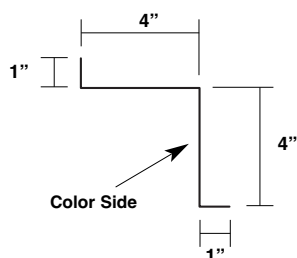

**Outside Corner Trim - Notched
MT-WAV-CRN-OS-STD**

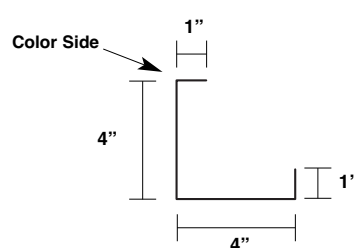

**Angle Trim
MT-194**

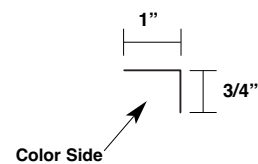

WAVE

TRIM

24 GA.

**Reveal Closure
MT-195**

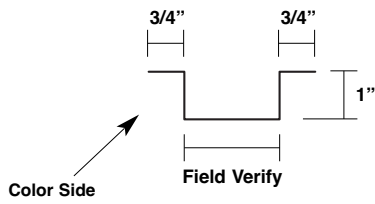

****Outside Corner Trim
MT-197**

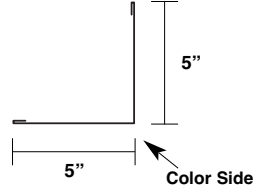

**For use in vertical installations.

****Inside Corner Trim
MT-198**

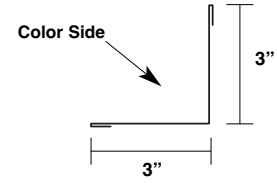

**For use in vertical installations.

****Vertical Splice Trim
MT-199**

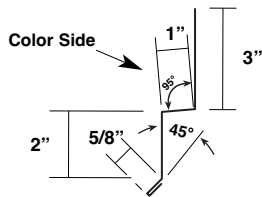

**For use in vertical installations.

WAVE

ACCESSORIES

Wave Floating Clip
(Houston Plant Only)
MT-193

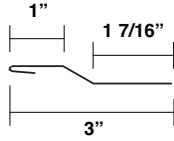

#10 - 12 x 1"
Type A Pancake Head
Woodgrip - Plain
Item #: 36116001

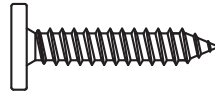

#10 - 16 x 1"
TEK2 Pancake Head
Self-Driller - Plain
Item #: 36117

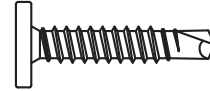

1/4 - 14 x 1 1/4"
Tek2 ZAC
(Part # varies by color.)

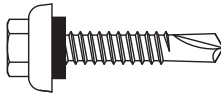

#10 - 15 x 1 1/2 HiLo ZAC
(Part # varies by color)

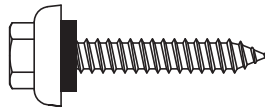

43D Pop Rivet
(Part # varies by color)

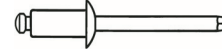

Outside Closure
32" w-Adhesive
Item #: 96022



Roll Tape Sealant 3/32" x 1" x 45'
Item #: 95335

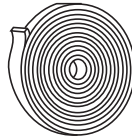

Touch-Up Paint Pen
(Part # varies by color)



**Each Closure Covers 2 Panels.

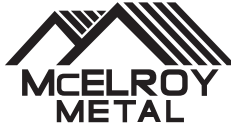

☆ MANUFACTURING LOCATIONS ● SERVICE CENTERS ★ MANUFACTURING AND SERVICE CENTER



CORPORATE OFFICE
1500 HAMILTON RD.
BOSSIER CITY, LA 71111

MANUFACTURING LOCATIONS

- | | | | | |
|--------------|--------------------|------------------|----------------|-------------|
| ADELANTO, CA | ASHBURN, GA | BOSSIER CITY, LA | CLINTON, IL | DIAMOND, MO |
| HOUSTON, TX | LEWISPORT, KY | MARSHALL, MI | MAUSTON, WI | MERKEL, TX |
| | PEACHTREE CITY, GA | SUNNYVALE, TX | WINCHESTER, VA | |

MCELROY METAL
SERVICE
C E N T E R

- | | | | |
|---|---|--|--|
| 17031 Koala Road
Adelanto, CA 92301 | 5215 Leo St.
Alexandria, LA 71301 | 1007 Wilso Dr,
Baltimore, MD 21223 | 1500 Hamilton Rd.
Bossier City, LA 71111 |
| 3052 Yadkin Road
Chesapeake, VA 23323 | 9476 Meadowbrook Rd.
Clinton, IL 61727 | 3215 Highway 59
Diamond, MO 64840 | 390 N. Valley Dell Dr.
Fenton, MO 63026 |
| 409 Lovejoy Road
Ft. Walton Beach, FL 32548 | 3014 Lincoln Court
Garland, TX 75041 | 1440 Aldine Bender Road
Houston, TX 77032 | 10504 E. 59th Street
Indianapolis, IN 46236 |
| 9435 US Hwy. 60 W.
Lewisport, KY 42351 | 1020 Veterans Street
Mauston, WI 53948 | 5123 Terminal Dr.
McFarland, WI 53558 | 514 Cave Road
Nashville, TN 37210 |
| 8304 Hwy. 70 E.
North Little Rock, AR 72117 | 613 North Bierdeman Rd.
Pearl, MS 39208 | 8511 Industrial Drive
Pearland, TX 77584 | 7450 Tower Street
Richland Hills, TX 76118 |
| 8200 Berry Ave. Suite 100
Sacramento, CA 95828 | 1365 Dean Forest Rd.
Savannah, GA 31405 | 7355 Oakley Industrial Blvd.
Union City, GA 30291 | |
| | 1144 Silstar Rd.
West Columbia, SC 29170 | 325 McGhee Rd.
Winchester, VA 22603 | |

Website: www.mcelroymetal.com • E-mail: info@mcelroymetal.com