

Matrix Soffit Panel

Product Data

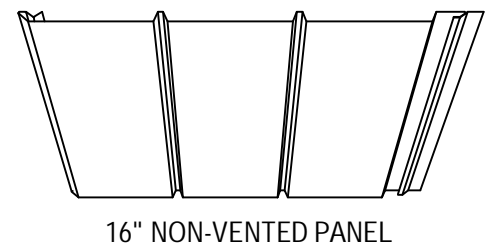
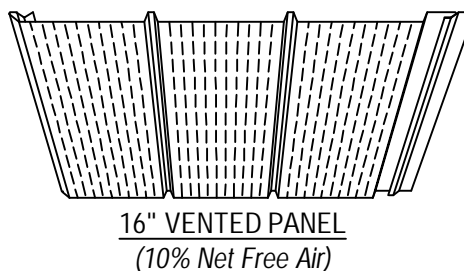
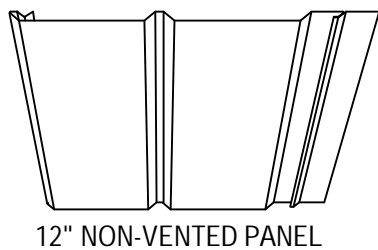
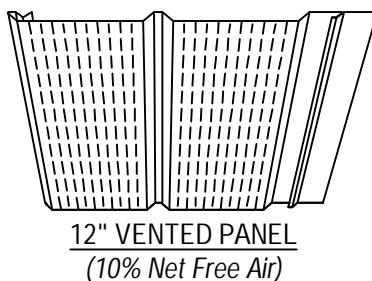
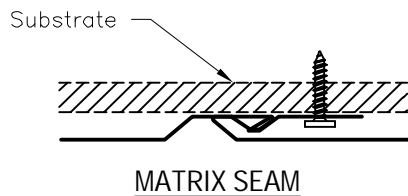
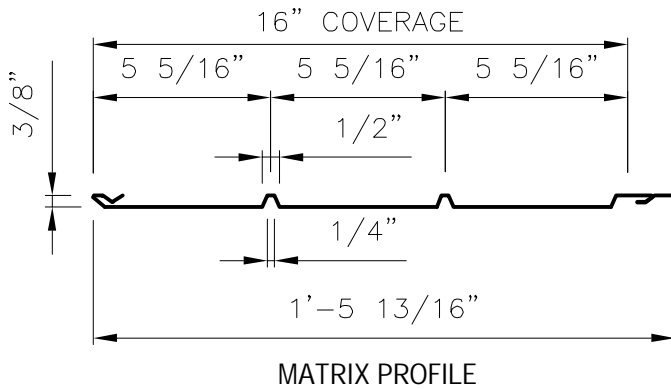
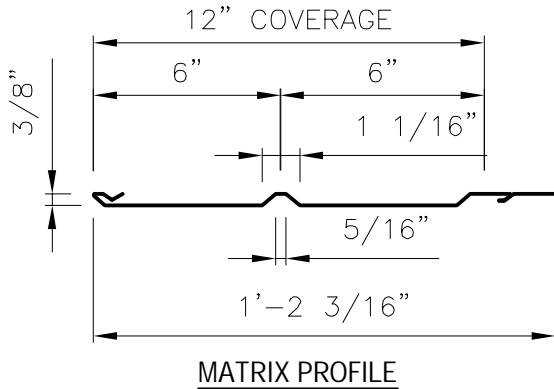

Applications

Concealed fastener soffit/wall panel. Standard panel lengths from 0'-6" to 4'-0".

Substrates

Plywood, Hat Section, Mac-Girts, or Wall Girts.

Material

Standard - 12" Matrix Panels

- 24 GA. ASTM A792 (50 ksi steel) AZ55 - Bare
- AZ50 - Painted
- 29 GA. ASTM A792 (37 ksi steel) AZ55 - Bare
- AZ50 - Painted

Standard - 16" Matrix Panels

- 26 GA ASTM A792 (50 ksi steel) AZ55 - Bare
- AZ50 - Painted
- 29 GA ASTM A792 (80 ksi steel) AZ55 - Bare
- AZ50 - Painted

Manufacturing

Roll formed in factory. (16" - Marshall Plant Only)

(12" - Lewisport Plant Only)

Finishes

Acrylic Coated Galvalume® - (12" ~ 24 GA & 29 GA)
- (16" ~ 26 GA & 29 GA)

Fluoropolymer (Kynar 500® PVDF resin-based)

- (12" ~ 24 GA & 29 GA)
- (16" ~ 26 GA)

Siliconized Polyester - (16" ~ 29 GA)

Pan Conditions

Vented or Non-Vented

Ventilation = 10% Net Free Air

Oil canning is inherent in all metal panels and is not cause for panel rejection. A signed oil canning acknowledgement will be required for all orders prior to production.

Testing *

Uplift: ASTM E1592

Testing and Approvals are product specific. Please inquire for details.